

EZ ELECTRIC POWER STEERING

INSTALLATION GUIDE

CHEVROLET CORVETTE C1

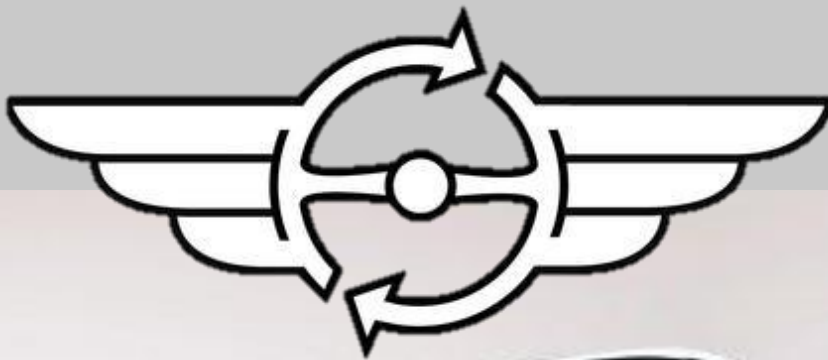

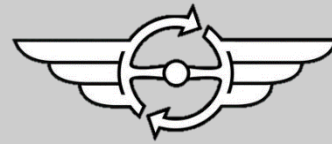

CONTENTS

| | |
|------------------------------|---|
| 1. THE PRODUCT _____ | 3 |
| 2. OVERVIEW OF THE KIT _____ | 4 |
| 3. INSTALLATION _____ | 6 |

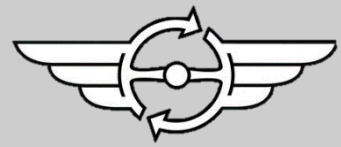

THE PRODUCT

Thank you for choosing an EZ ELECTRIC POWER STEERING product for its quality, its performance, type approval and its straightforward assembly. Since 2006 we have been manufacturing complete steering columns with integrated electrical assistance. All columns are tailor made for each type of car and we have over 200 different types in stock. For more information about our products (power steering systems and replica steering wheels) or to place an order, visit our website www.ezpowersteering.com or send an e-mail to info@ezpowersteering.nl. If you have any questions of a technical nature please contact workshop@ezpowersteering.nl.

Version C1.1

Date 14-04-2022

This manual should be read carefully to avoid errors. Check whether all parts of the set are present. This can be done on the basis of the picture in this manual. Before installation, compare the EZ POWER STEERING column with the original column. Check that the dimensions are the same. Also fit the steering wheel to the column.

If you do not have the skills or tools to perform the installation, have it performed by a professional. EZ POWER STEERING cannot be held liable for incorrect installation or self-inflicted damage.

The manuals are generally based on a left-hand-drive vehicle. In most cases, the right-hand drive version is the mirror image of the installation of a left-hand drive vehicle.

If you think that any changes are needed in this manual, we would like to receive your pictures and comments. With your feedback we can improve our manuals!

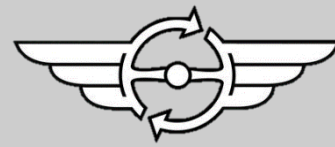

OVERVIEW OF THE KIT



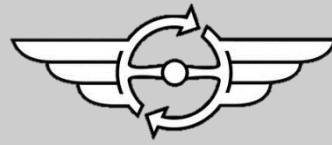

EZ-CORVC1-1. Complete clamp set

EZ-CORVC1-2. Drilling block with drill

EZ-CORVC1-3. Bolts and washer

EZ-CORVC1-4. Clamp adapter

EZ-CORVC1-5. Loctite

EZ-CORVC1-6. Temporary bearing (black or white) to keep the axle as much as possible in place during cutting. After cutting, this temporary bearing can be removed again.

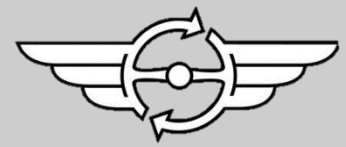

INSTALLATION

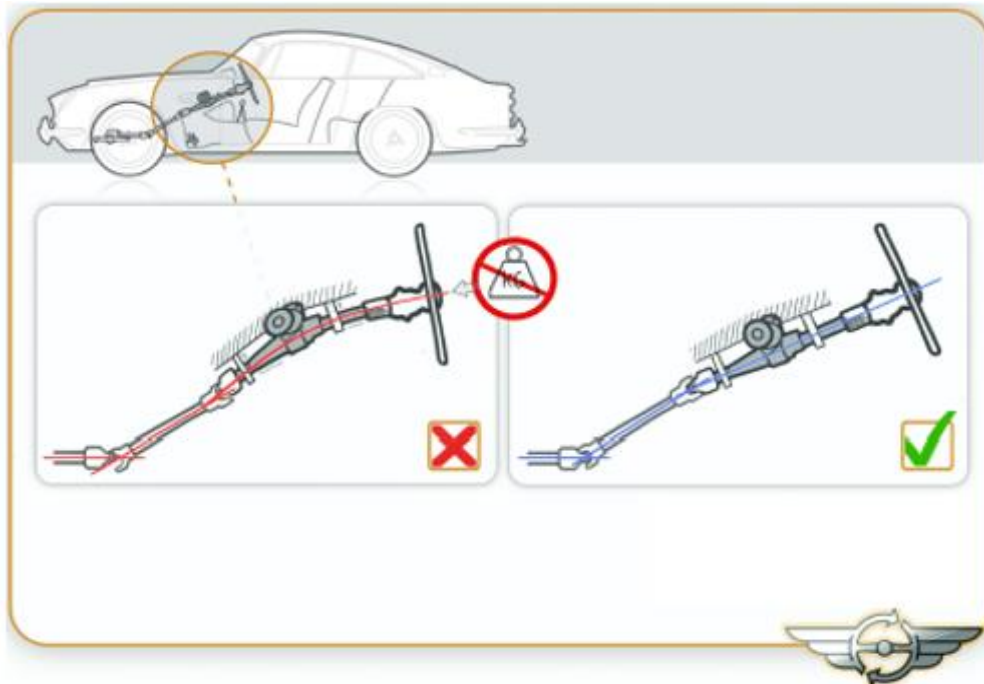

The steering system must always be properly aligned and mounted without tension.

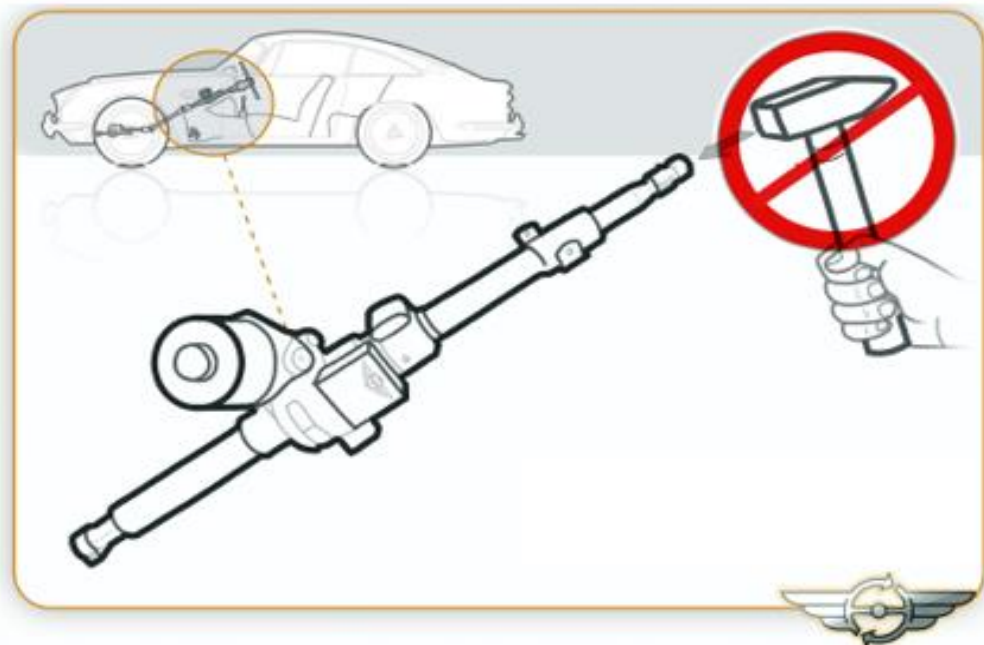

Never strike the input shaft with an object during or after assembly. This can adversely affect the sensors.

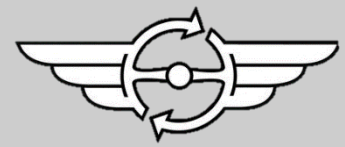

Check length, diameter and splines

Compare the EZ Power Steering Column (EZ-unit) with the original steering column before installing it. Check if the splines on the top and bottom, the diameter of the steering tube and the length of the column are all the same as the original steering column. When in doubt you can use the original steering wheel to check the top splines for fit. Never hammer on the steering shaft of the EZ unit!

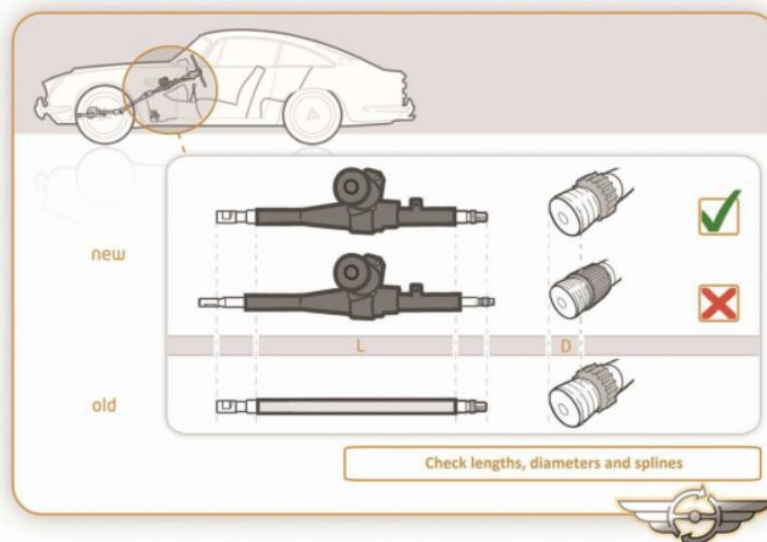

In the car industry its common to have some small tolerances in spline connections. In very exceptional cases connecting a new shaft from the EZ-unit in the original (old) U-joint could cause a tight fitting. This is sometimes relatively easy to solve by sanding only about 0,2mm (0,007 inch) in the inner part of the U-joint and also the spline on the output shaft on the EZ-unit.





Torque tightening values in Nm.

When the new steering column is being fitted hand tighten all the bolts and check if everything turns smoothly before tightening to required Torque, use torque tightening table below:

| | Alu | 8.8 | 10.9 | 12.9 |
|----|-----|-----|------|------|
| M6 | 6 | 11 | 16 | 19 |
| M8 | 15 | 27 | 40 | 47 |

The system works with a torsion bar into the unit, this measures the amount of torque/load on the steering shaft while steering, the torque sensor measures this and sends a voltage to the ECU. The ECU uses this signal together with the speed signal to control the electric motor from the EZ-unit

Voltage

The basic EZ-unit, is a 12V system with negative earth! There are extra wiring sets available, so that the kit will work with a 6V or 24V system and/or positive earth. Check your vehicle setup before fitting the EZ-unit.

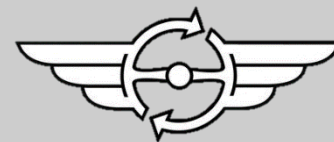

INSTALLATION

Step 1.

Take the car for a test drive and check the original steering system for defects. If everything is working correctly, continue with the conversion.

Step 2.

Locate an ignition switched 12v plus and label this wire. This is needed to control the EZ unit (see point 25). Align the steering system to its center position. Disconnect the battery earth.



Step 3.

Remove the steering wheel with horn contact.

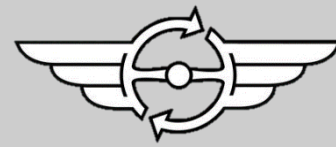

Step 4.

Remove the cover underneath the column.

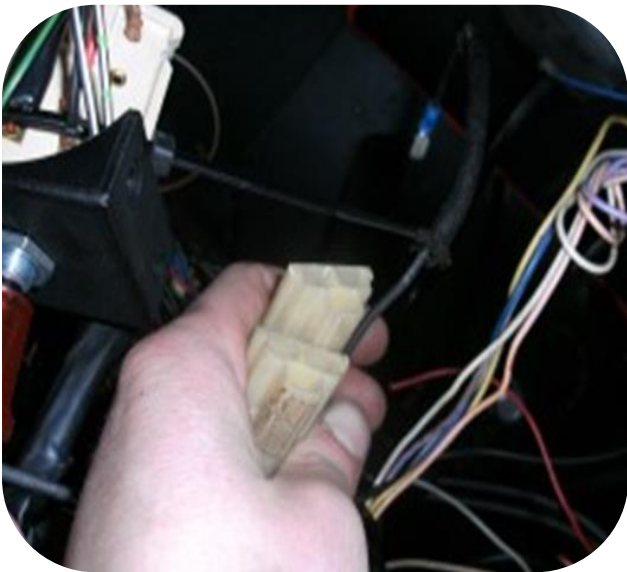

Step 5.

Disconnect the connectors from the original steering column.

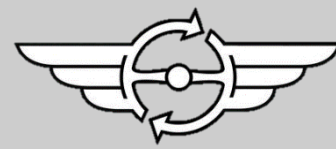

Step 6.

Remove spring & washer behind the steering wheel.



Step 7.

Remove the indicator stalk, this can be unscrewed from the switch.

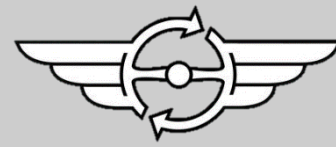

Step 8.

Remove the cover. After the screw(s) has been removed the cover can be removed.

Measure the distance, to see how much the steering shaft sticks out the from the steering column. note this length.



Step 9.

Remove the bracket from the steering column underneath the dash.

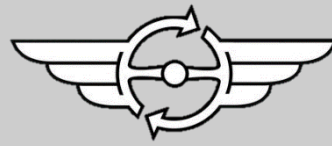

Step 10.

Cut the original steering tube, use the EZ unit to determine where to cut.



Step 11.

Measure the total length from the EZ steering shaft with the installed clamp adapter. This value, minus the inner depth from the clamp adapter (52mm), is the right length to cut from the steering shaft.

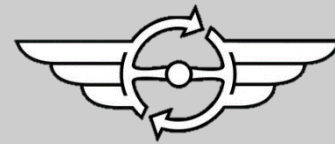

Step 12.

Measure the distance back from the top of the original steering shaft. Be sure that you have a straight cut.

NOTE: Temporary bearing (black or white) to keep the axle as much as possible in place during cutting. After cutting, this temporary bearing can be removed again.

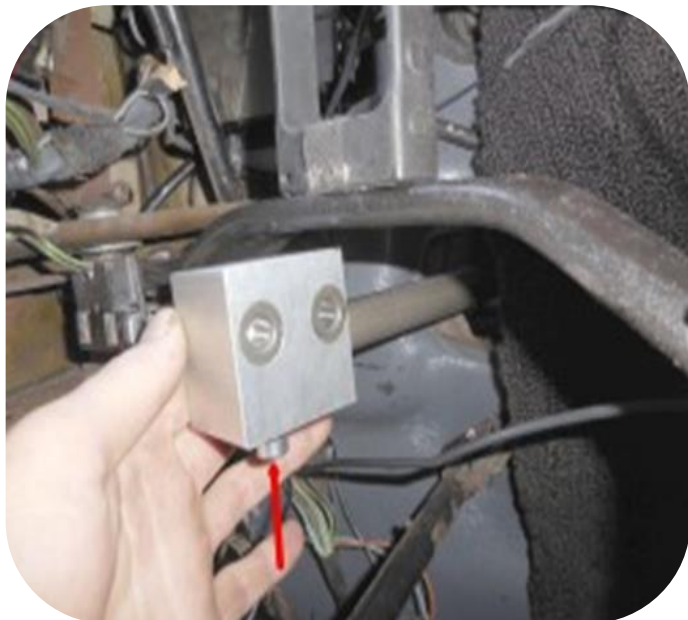

Step 13.

Slide the drilling block over the original steering shaft and use the bolt to lock it into place. Now use the supplied 8.5mm drill to create the notches into the shaft.

TIP: Get the steering system to its max position to prevent the shaft from turning during drilling. Leave the drill bit out of the hole from time to time to allow drill chips to come out.

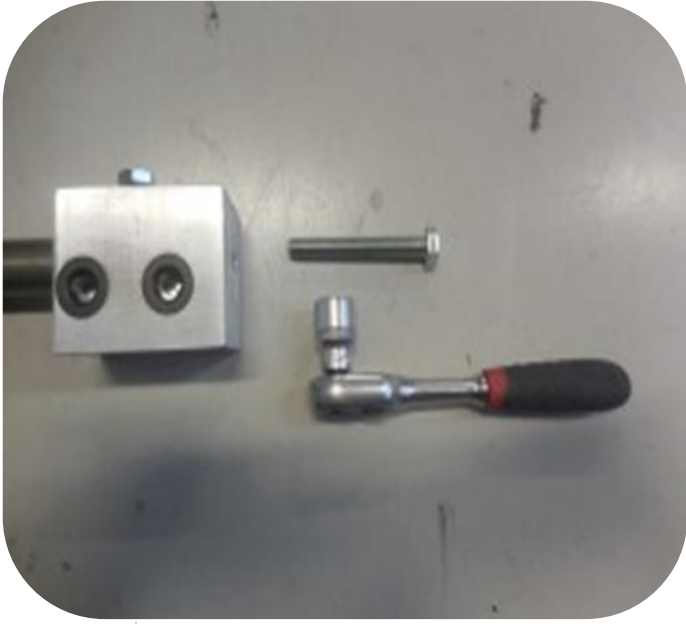
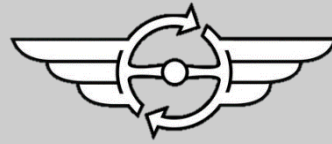

Step 14.

For easy removal from the drilling tool, there is a hole with thread on the back on the tool, when using a long M8 bolt the tool can be pressed of the original shaft easily.

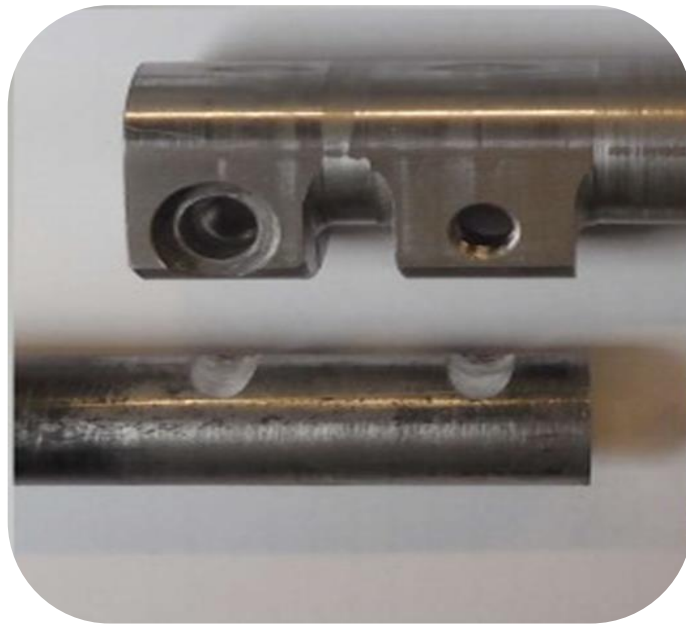

Step 15.

These notches are needed to give the bolts enough clearance, to ensure a good installation.

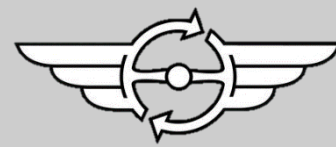

Step 16.

Deburr and clean the shaft after drilling. Check if the clamp adapter fits well and if the notches line up with the clamp.



Step 17.

Now install the clamp adapter onto the steering shaft. Tighten the bolts with 35NM (25.8 lb-ft). Do not forget to install the supplied washer under the bolts. Now slide the output tube over the clamp onto the earlier cut original steering tube.

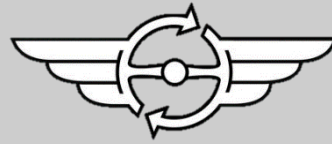

Step 18.

The earlier-cut, original steering tube, needs to be shortened so that it can be installed onto the EZ unit. Use the EZ unit to determine the right length.

Tip: be sure that the length from step 8 corresponds.



Step 19.

Install the EZ unit into the car. Install it onto the adapter first.

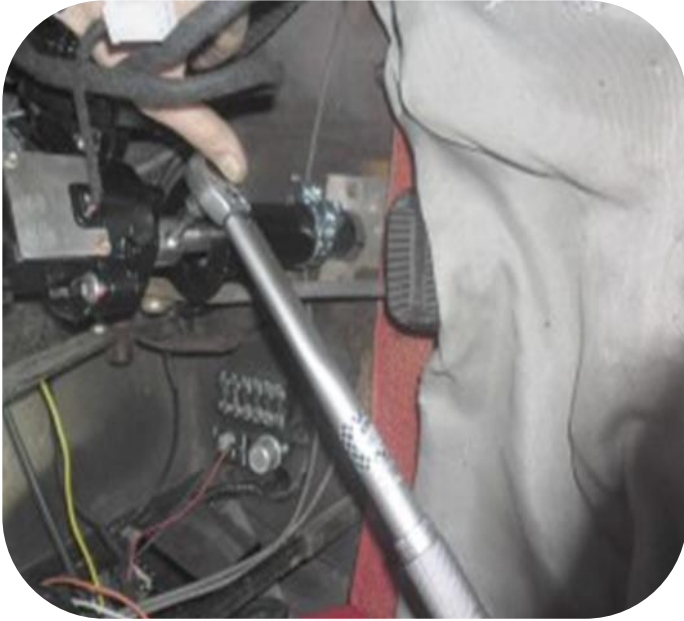
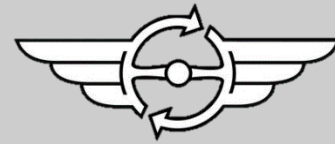

Step 20.

Once the column is positioned and aligned correctly (do not forget the upper bracket) tighten the last bolt from the clamp adapter with 35NM (25.8 lb-ft), do not forget the washer underneath this bolt.



Step 21.

Install the output tube onto the EZ unit and tighten the bolts/clamp.

Step 22.

Locate a suitable location for the ECU and install it.

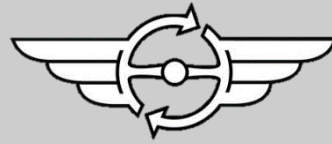

Step 23.

Reconnect the original connectors from the steering column.

Step 24.

Install the indicator switch cover and stalk onto the steering column.

Step 25.

Install the cover underneath the column.

Step 26.

Connect the thin red wire (15+) with an ignition switched feed (step 2).

Step 27.

Connect the thick red wire (30+) through the fuse holder directly with the battery plus.

Step 28.

Connect the black earth wire (31-) with a suitable earth point.

Step 29.

Locate a suitable location for the potentiometer and install it.

Step 30.

Install ring, washer and steering wheel onto the EZ unit. Do not forget the horn contact pin.

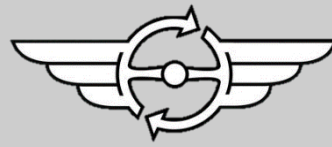

Step 31.

When the ignition has been switched on there is a click noticeable from the ECU, the system is now operational, check this. The system turns off with a slight delay, this is noticeable by the click after a couple of seconds. This is how it should function.

Step 32.

Take the car for test drive and recheck all systems.